

Wall Spot

Cat. No. WS

Cat. No. WS/R

Cat. No. WSGU

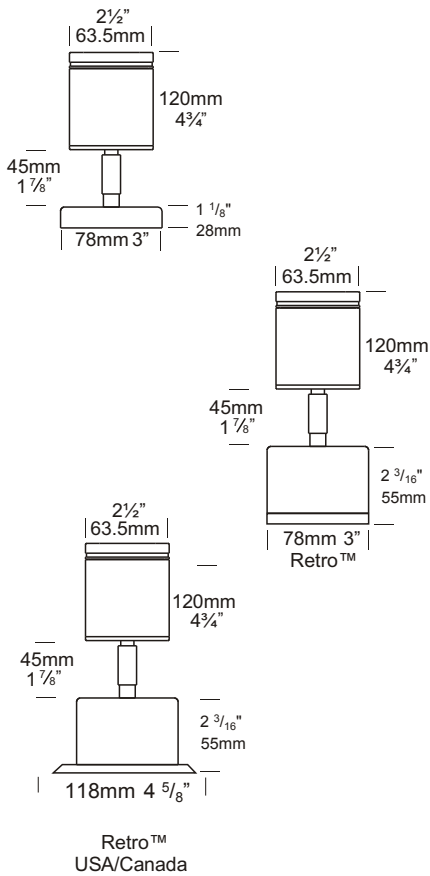

The Wall Spot has been designed to be mounted on walls and provide directional light for pathways and structural elements of a building. This luminaire has a fully adjustable head allowing 360 degree rotation and 0 - 90 degree elevation.

This luminaire is machined from a choice of 10mm solid aluminium with a UV stable powder coated finish, solid copper or 316 stainless steel with a clear, tempered, flush glass lens and high temperature silicon gaskets.

The Retro™ is a 110/240-12 ac mains option suited to an installation where mounting a transformer is a problem, e.g. a brick wall where there is only the cable protruding out of the wall and it is not an option to recess the transformer or when replacing an existing light fitting. The base size increases in size to accommodate the encapsulated IP66 dimmable transformer.

A GU10 version of this luminaire is also available for line voltage lamps. However, a longer body is needed to accommodate the longer lamp.

Ordering Information

Luminaire Type

WS - Wall Spot

Material/Finish

- BK - Black
- BZ - Bronze
- GN - Green
- STAR - Silver Star
- WH - White
- WB - Birch
- DG - Dark Grey
- OG - Olive Green
- RG - Beige
- PR - Primrose
- COP - Copper
- SS - 316 Stainless Steel

Accessories

- CJK150 - Cable Joint Kit
- LENSSTEPF - Frosted Lens
- GG - Glare Guard
- HCL - Hex Cell Louvre
- /R - Retro™ Transformer
110/240-12 volt
- WBAP - Wall Box Adaptor Plate
- GU - GU10 Option



Ordering Example: WS BK - Wall Spot in Black
 WS/R SS - Wall Spot Retro™ in 316 Stainless Steel
 WSGU SS - Wall Spot GU10 in 316 Stainless Steel
 (Accessories ordered separately)

HUNZA™ PURE
OUTDOOR
LIGHTING

HUNZA FACTORY
130 Felton Mathew Ave
Glen Innes
Auckland 1072
New Zealand

Ph: 64-9-528 9471
Fax: 64-9-528 9361
hunza@hunza.co.nz
www.hunza.co.nz

INTERNATIONAL CONTACTS:
www.hunza.co.nz/contacts.php

Specifications may change without notice.
Manufactured in New Zealand.
© 2011 Hunza Holdings Ltd.

Ver 1.4

Luminaire Construction

CNC machined from the following metals:

Body: High corrosion resistant low copper 63.5mm (2½") x 10mm (25/64") aluminium. End cap - solid aluminium 63.5mm (2½") rod.

Base & Mounting Plate (Retro™): Cast from virgin high corrosion resistant CC401 low copper aluminium alloy chromate substrate and high UV resistant polyester powder coat - Black, Bronze, Green, Silver Star, White, Birch, Dark Grey, Olive Green, Beige, Primrose.

Body: Copper 63.5mm (2½") x 10mm (25/64). End cap - solid copper 63.5mm (2½") rod.

Base: Copper Hand spun 2mm (5/64").

Mounting Plate: Forged brass (Retro™).

Body: 316 Stainless Steel 63.5mm (2½") x 10mm (25/64) rod. End cap - 316 stainless steel 63.5mm (2½") rod.

Base: Investment cast and CNC machined.

Mounting Plate: Investment cast and CNC machined (Retro™).

Mounting

12 volt: the luminaire is mounted to the wall using two 316 stainless screws through a shallow base 16mm (5/8") in depth. A Wall Box Adaptor Plate is available as an accessory to fit 3.0 and 4.0 Junction boxes for USA /Canada.

Retro™ luminaire (110/240-12volt): a mounting plate is fixed to the wall using two screws and the luminaire is fitted to the mounting plate.

Features

Lens:

10mm (3/8") clear flush fit tempered shatter resistant glass.

Lifetime Warranty.

Gasket: Silicone, iron impregnated 220°C (428°F).

Lamp Holders:

GU5.3 & GU10 - 350°C (662°F) ceramic multi contact lamp holder with 250°C (480°F) teflon cables.

Accessories:

Cable Joint Kit (Cat CJK150).

Not approved for USA /Canada.

Frosted Lens (Cat. LENSSTPEPF).

Glare Guard (Cat. GG).

Hex Cell Louvre Adaptor (Cat. HCL).

Retro™ transformer 110/240-12 volt (Cat. /R).

Wall Box Adaptor Plate (Cat. WBAP 12 volt luminaire USA/Canada). GU10 Option (Cat. GU).

Swivels: Aluminium and Copper

luminaires - 360° rotation and 0 - 90° elevation, solid brass with anti rust spring.

Stainless Steel luminaires - 360° rotation and 0 - 90° elevation, full stainless steel construction.

Standards

IP66 AS/NZS61046  UL1838

Luminaire Weight

12 volt

Alum .495kg (1lb 1oz)

Cop 1.300kg (2lb 13oz)

SS 1.080kg (2lb 6oz)

Retro™

Alum .900kg (1lb 15oz)

Cop 1.710kg (3lb 12oz)

SS 1.500kg (3lb 4oz)

Power Supply

12 volt - HUNZA Inground or HUNZA Wall Mount Transformer: not included.

USA and Canada:

HUNZA™ Wall Mount Transformer: not included. Approved for internal use.

RETRO™

HUNZA™ 110/240-12 volt ac potted electronic transformer built into the Retro™ base. Dimmable with a suitable dimmer.

Approved for internal use.

Luminaire: supplied with

MR16 GU5.3 20 or 35 watt lamp max.

GU10 - GU10 25 or 35 watt lamp max.

USA and Canada:

MR16 GU5.3 20 or 35 watt lamp max.

GU10 Halogen - Lamp not supplied

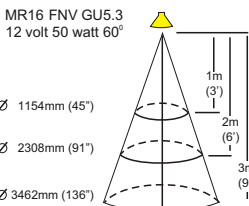
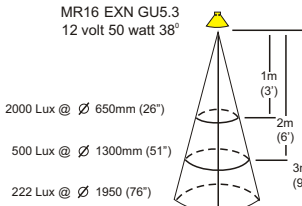
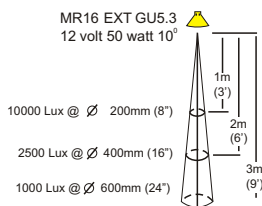
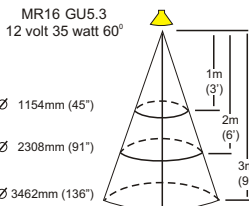
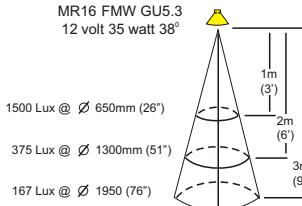
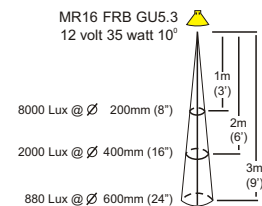
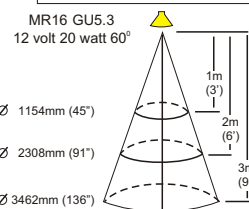
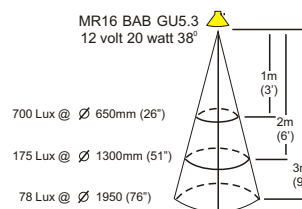
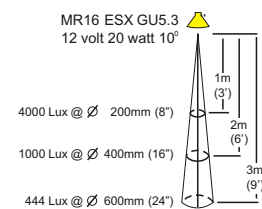

HUNZA™ PURE OUTDOOR LIGHTING

HUNZA FACTORY
130 Felton Mathew Ave
Glen Innes
Auckland 1072
New Zealand

Ph: 64-9-528 9471
Fax: 64-9-528 9361
hunza@hunza.co.nz
www.hunza.co.nz

INTERNATIONAL CONTACTS:
www.hunza.co.nz/contacts.php

Specifications may change without notice.
Manufactured in New Zealand.
© 2011 Hunza Holdings Ltd.

Ver 1.4