

Lawn Lite Deck Mount PURE LED

PROJECT:
TYPE:
SOURCE:
NOTES:

SPECIFICATIONS

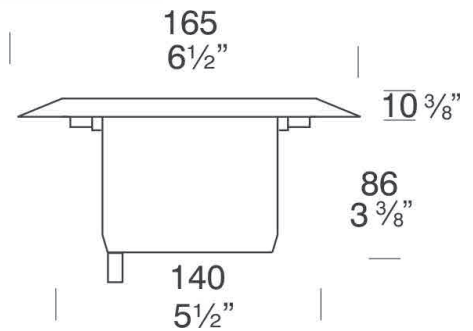

LED Chip	Cree XHP-50-2 Plug and Play field replaceable LED board
Luminaire Output	600 Lumens @ 1050mA (6 watts), 420 Lumens @ 700mA (4 watts), 240 Lumens @ 350mA (2 watts), delivered from luminaire with unobstructed beam.
Lumens Per Watt	100 Lumens @ 6 watts minimum, delivered from luminaire with unobstructed beam
CRI (3000K)	85+ Standard, 90+ Optional
Colour Temperatures	2700K, 3000K, 4000K
Beam Angles	15, 25, 38, 60
Ingress Protection	IP67
Warranty	Electronics = 5 years Flange SBZ/SS = 10 years Body Aluminium = 5 years
Standards	AS/NZS 61046 cUL 1838, 2108 CSA 22.2 No. 250.7, No. 250.0-08, CE

PRODUCT CONFIGURATION

Please fill in appropriate codes into boxes provided

Cat. No. LLDMMV/L

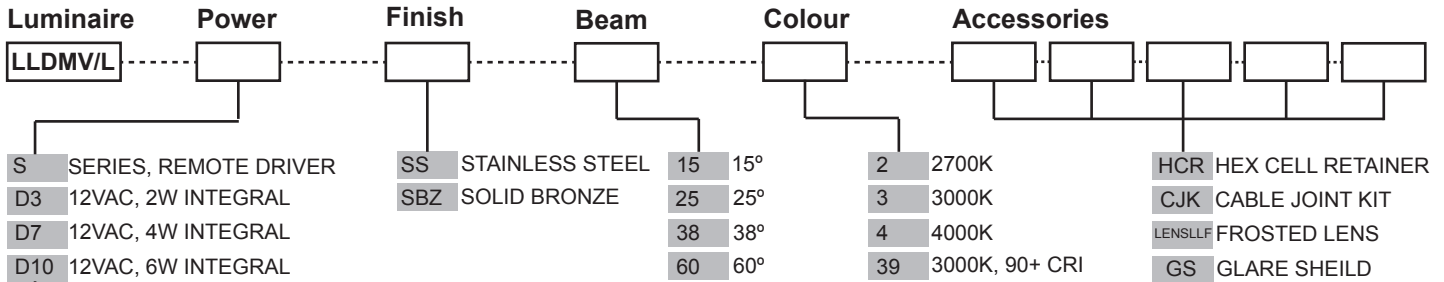

SERIES, REMOTE DRIVER REQUIRED:
Constant current driver
Individual fixtures require 6vdc @ 1050mA maximum

12VAC INTEGRAL DRIVER:
Hunza integrated plug and play driver (included)
Input: 9-15VAC.
Output: 6vdc @ D3=350mA, D7=700mA, D10=1050mA (1050mA limited to ≤ 40°C (104°F) ambient temperature in stainless steel)

ADDITIONAL COMMENTS:

[Please click for Hunza Power Supply selection Chart](#)
[Please click for Hunza Voltage drop Chart](#)

LUMINAIRE CONSTRUCTION

CNC machined from one of the following metals:

Aluminium:

Body: cast from high corrosion resistant CC401 low copper aluminium alloy, with chromate substrate and high UV resistant polyester double powder coated.
Colour: Black

Solid Bronze:

Flange: solid bronze bar 165mm (6½")

316 Stainless Steel:

Flange: 316 stainless steel 165mm (6½") rod.

Flange:

The flange is attached to the body by three 316 stainless steel allen head anti vandal screws.

Lens:

12mm (1/2") extra clear, low iron, flush fit, shatter resistant glass.
Lifetime warranty

Gaskets:

Silicone 220°C (428°F)

Mounting:

Deck Mount version for mounting through a 145mm (5½") hole in a wooden or concrete deck.
Lawn Lite Deck Mount version is not suitable for driving over.

Luminaire Weight:

Low voltage
SBZ: 1.220kg (2lb 11oz)
SS: 1.510kg (3lb 5oz)

ACCESSORIES

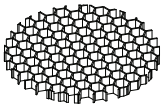

Hex Cell Retainer

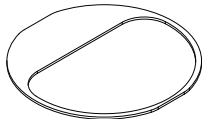

Glare Shield

BEAM ANGLES

High efficiency PMMA TIR lenses. Field replaceable

IES files available for download: <http://www.hunzalighting.com/download.php>

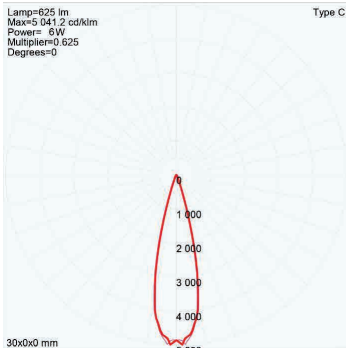

15° FWHM TIR

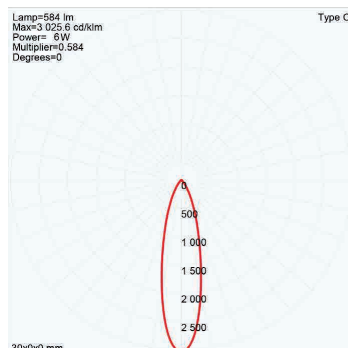

25° FWHM TIR

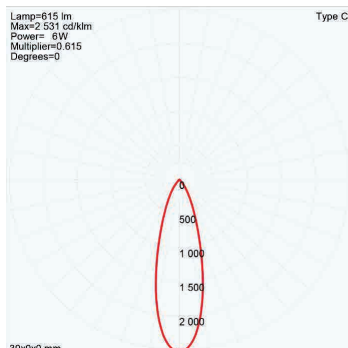

38° FWHM TIR

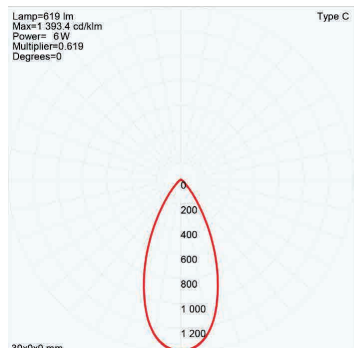

60° FWHM TIR

WIRING GUIDE

Series/remote driver

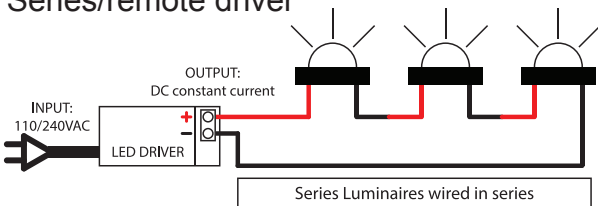

Diagrams are a guide only, wire colours and polarity may change depending on fixture and country

available for download: <http://www.hunzalighting.com/download.php>

12v integral driver

