

# Pole Spot

Cat. No. PS

Cat. No. PSGU

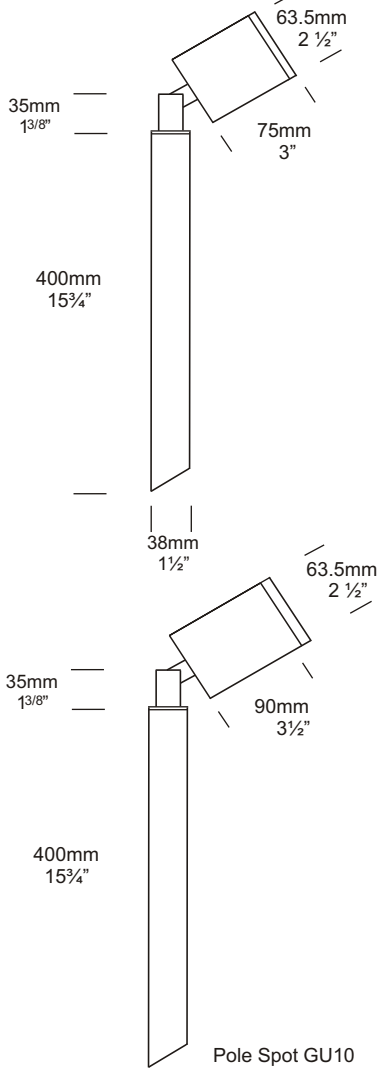

The Pole Spot has a single spotlight which can be aimed in any single direction. This luminaire is ideal for path lighting as well as tree lighting, or the head may be aimed downward stopping upward light altogether. The fitting has a fully adjustable head which allows for 360 degree rotation, as well as a high degree of elevation.

This luminaire is machined from a choice of 10mm solid aluminium with a UV stable powder coated finish, solid copper or 316 stainless steel with a clear, tempered, flush glass lens and high temperature silicon gaskets. The Pole Spot uses a MR16 GU 5.3 lamp.

A GU10 version of this luminaire is also available for line voltage lamps. However, a longer body is needed to accommodate the longer lamp.

## Ordering Information

### Luminaire Type

PS - Pole Spot

### Material/Finish

- BK - Black
- BZ - Bronze
- GN - Green
- STAR - Silver Star
- WH - White
- WB - Birch
- DG - Dark Grey
- OG - Olive Green
- RG - Beige
- PR - Primrose
- COP - Copper
- SS - 316 Stainless Steel

### Accessories

- CJK150 - Cable Joint Kit
- LENSSTEPF - Frost Lens
- GG - Glare Guard
- HCL - Hex Cell Louvre Adapter
- GU - GU10 Option

For LED options, refer to page 10.4 (dedicated LED), 10.4.3 (6 watt), 10.4.4 (3 watt) or <http://hunza.co.nz/l.html>

Ordering Example: PS COP - Pole Spot in Copper  
 PSGU COP - Pole Spot GU10 in Copper  
 GG COP - Glare Guard in Copper  
 (Accessories ordered separately)

**HUNZA**™ PURE OUTDOOR LIGHTING

**HUNZA FACTORY**  
 130 Felton Mathew Ave  
 Glen Innes  
 Auckland 1072  
 New Zealand

Ph: 64-9-528 9471  
 Fax: 64-9-528 9361  
[hunza@hunza.co.nz](mailto:hunza@hunza.co.nz)  
[www.hunza.co.nz](http://www.hunza.co.nz)

**INTERNATIONAL CONTACTS:**  
[www.hunza.co.nz/contacts.php](http://www.hunza.co.nz/contacts.php)

Specifications may change without notice.  
 Manufactured in New Zealand.  
 © 2011 Hunza Holdings Ltd.

Ver 1.4

## Luminaire Construction

CNC machined from one of the following metals:

High corrosion resistant 63.5mm (2½") x 10mm (25/64") aluminium. End cap - solid aluminium 63.5mm (2½") rod, with chromate substrate and high UV resistant polyester powder coat - Colours Black, Bronze, Green, Silver Star.

**Copper** 63.5mm (2½") x 10mm (13/32"). End cap - solid Copper 63.5mm (2½") rod.

**316 Stainless Steel** 63.5mm x 9mm. End cap - solid 316 Stainless Steel 63.5mm (2½") rod.

**Poles** Aluminium, Copper, 316 Stainless Steel 38mm (1½") x 400mm (15¾").

## Mounting

The pole 400mm (15¾") is directly mounted into the earth or concrete.

## Features

**Lens:**  
10mm (3/8") clear 'flush fit' shatter resistant glass. Lifetime Warranty.

**Gaskets:**  
Silicone, iron impregnated 220°C (428°F).

**Lamp Holder:**  
GU5.3 & GU10 - 350°C (662°F) ceramic multi contact lamp holder with 250°C (480°F) teflon cables.

**Accessories:**  
Cable Joint Kit (Cat. CJK150).  
Frosted Lens (Cat. LENSSTEPF).  
Glare Guard (Cat. GG).  
Hex Cell Louvre Adapter (Cat. HCL).  
GU10 Option (Cat. GU).

**Swivel:**  
Aluminium and Copper Luminaires 360° rotation and a high degree of elevation, solid brass with anti rust spring.

Stainless Steel luminaires 360 degree rotation and a high degree of elevation, full 316 stainless steel construction.

## Standards

IP66



## Luminaire Weight

Alum 1.00kg (2lb 3oz)  
Cop 1.70kg (3lb 12oz)  
SS 1.50kg (3lb 5oz)

## Power Supply

HUNZA™ Inground or Wall Mount Transformer: Not included

## Luminaire: Supplied With

MR16 GU5.3 20 or 35 watt lamp max.  
GU10 - GU10 25 or 35 watt lamp max.

**LED** - Refer to previous page.

## USA and Canada:

MR16 GU5.3 20 or 35 watt lamp max.  
GU10 Halogen - Lamp not supplied

**LED** - Refer to previous page.

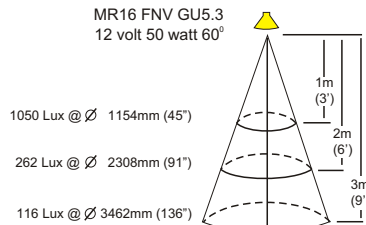
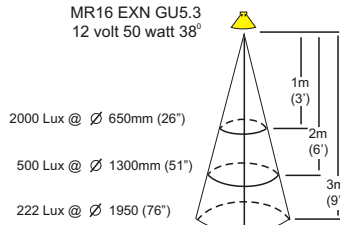
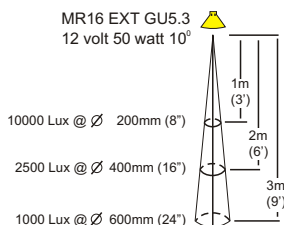
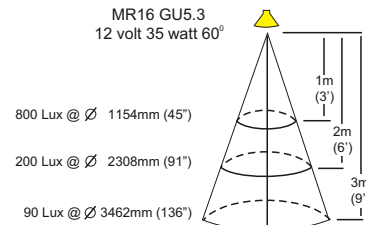
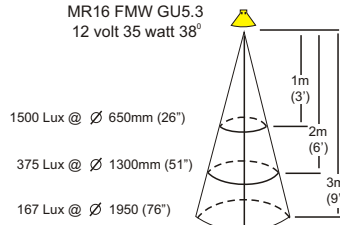
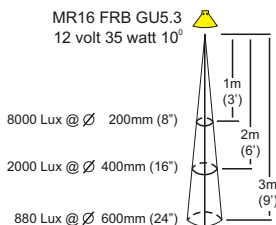
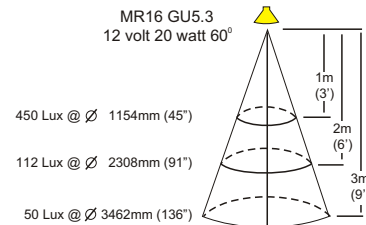
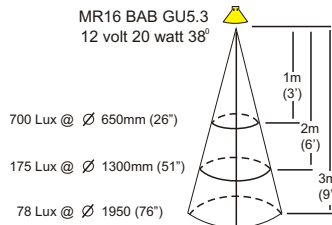
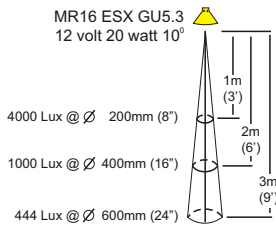

**HUNZA™** PURE OUTDOOR LIGHTING

**HUNZA FACTORY**  
130 Felton Mathew Ave  
Glen Innes  
Auckland 1072  
New Zealand

Ph: 64-9-528 9471  
Fax: 64-9-528 9361  
hunza@hunza.co.nz  
www.hunza.co.nz

**INTERNATIONAL CONTACTS:**  
www.hunza.co.nz/contacts.php

Specifications may change without notice.  
Manufactured in New Zealand.  
© 2011 Hunza Holdings Ltd.

Ver 1.4