

# Pool Lite

Cat. No. POOL

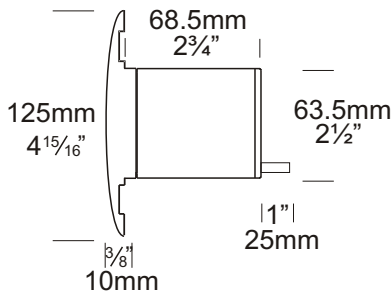

Pool Lite is electro polished for extra corrosion protection and is held into the PVC canister by two 'O' rings. There are no mounting screws in the flange to spoil the aesthetics of this luminaire. Up to 600mm (2") of cable can be coiled up inside the mounting canister enabling the luminaire to be removed for lamp changing above the water line. Complete with six metres (18') of submersible cable. Longer cable available on request.

The Pool Lite PVC canister can be ordered separately as an accessory.

## Ordering Information

Luminaire Type	Material	Accessories
POOL - Pool Lite	SS - 316 Stainless Steel	CJK150 - Cable Joint Kit HCL - Hex Cell Louvre Adaptor LENSSTEPF - Frosted Lens PLCAN - Pool Lite PVC Canister PLCAN100 - Pool Lite PVC Canister 100mm

Ordering Example: POOL SS - Pool Lite in 316 Stainless Steel  
PLCAN - Pool Lite PVC Canister  
CJK150 - Cable Joint Kit  
(Accessories ordered separately)

Pool Lite PVC Canister 100mm

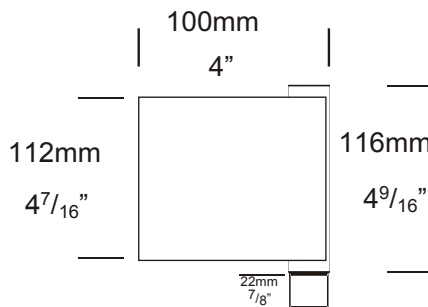

Pool Lite PVC Canister

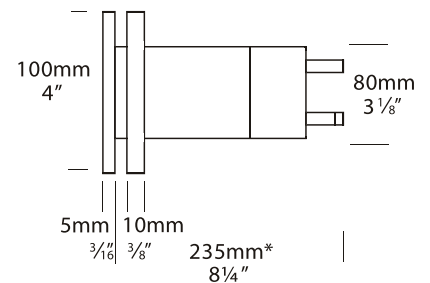

**HUNZA**™ PURE OUTDOOR LIGHTING

**HUNZA FACTORY**  
130 Felton Mathew Ave  
Glen Innes  
Auckland 1072  
New Zealand

Ph: 64-9-528 9471  
Fax: 64-9-528 9361  
hunza@hunza.co.nz  
www.hunza.co.nz

**INTERNATIONAL CONTACTS:**  
[www.hunza.co.nz/contacts.php](http://www.hunza.co.nz/contacts.php)

Specifications may change without notice.  
Manufactured in New Zealand.  
© 2011 Hunza Holdings Ltd.

Ver 1.4

## Luminaire Construction

CNC machined from:

Body: 316 Stainless Steel 9mm (1/3").

Endcap: Solid 316 Stainless Steel 63.5mm (2 1/2") rod, electro polished to increase corrosion protection by up to 33%.

Canister:

CNC machined from engineering grade PVC with moulded PVC end cap which has 20mm (3/4") conduit entry for electrical connections.

## Mounting

The PVC mounting canister is suitable for installation into three different types of pool wall: 1) Fibreglass pools, 2) Existing concrete pools, 3) New concrete pools.

*Warning - out of balance pool chemicals may cause the luminaire to corrode at a rapid rate. In salt water an increase in water temperature of 10 degrees will double the corrosion factor. 316 stainless steel is suitable for situations of up to 1000 parts per million of chloride. Where an automatic chlorinator is employed an excess amount of chlorine may be produced. The Hunza Pool Lite is electro-polished, this finish increases the protection against corrosion by up to 33%.*

## Features

Lens:

10mm (3/8") thick clear 'flush fit' tempered shatter resistant glass

Lifetime Warranty.

Gaskets:

Silicone, iron impregnated 220°C (428°F).

Lamp Holder:

GU5.3 - 350°C (662°F) ceramic lamp holder with 250°C (480°F) teflon cables.

Cable:

1.3mm (16AWG) x 6 metres (18') submersible cable, longer cable available on request.

\*USA version includes an earth wire.

Accessories:

Cable Joint Kit (Cat. CJK150). Not approved for USA/Canada.

Frosted Lens (Cat. LENSSTEPF).

Hex Cell Louvre Adaptor (Cat. HCL).

Pool Lite PVC Canister

(Cat. PLCAN)

Pool Lite PVC Canister 100mm

(Cat. PLCAN100)

## Standards

EN60598

IP68



UL676

## Luminaire Weight

1.885kg (4lbs 2oz)

## Power Supply

HUNZA™ H50: not included.

USA and Canada:

Ground Shield Transformer: not included.

Luminaire: supplied with

MR16 GU5.3 20 or 35 watt lamp max.

**LED** - Refer sheet no. 10.4

USA and Canada:

MR16 GU5.3 20 or 35 watt lamp max.

**LED** - Refer sheet no. 10.4

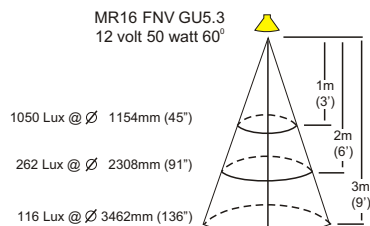
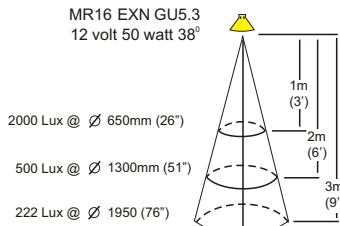
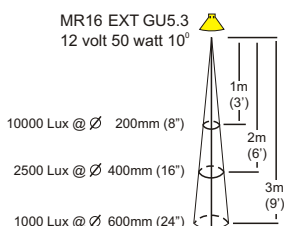
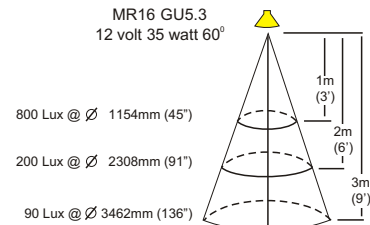
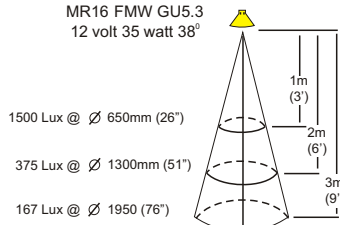
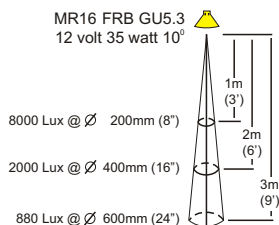
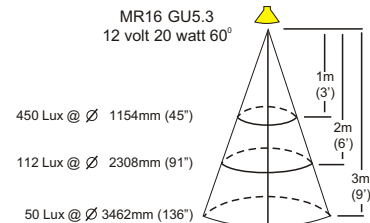
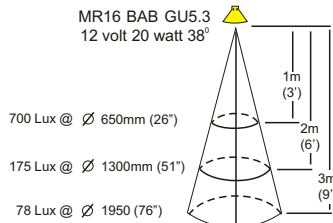
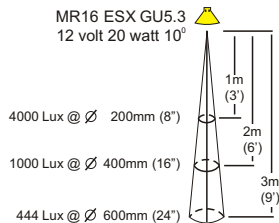

**HUNZA**™ PURE OUTDOOR LIGHTING

**HUNZA FACTORY**  
130 Felton Mathew Ave  
Glen Innes  
Auckland 1072  
New Zealand

Ph: 64-9-528 9471  
Fax: 64-9-528 9361  
hunza@hunza.co.nz  
www.hunza.co.nz

**INTERNATIONAL CONTACTS:**  
www.hunza.co.nz/contacts.php

Specifications may change without notice.  
Manufactured in New Zealand.  
© 2011 Hunza Holdings Ltd.

Ver 1.4