

Spike Spot

Cat. No. SS

Cat. No. SSGU

Cat. No. SSMH20

Cat. No. SSMH35

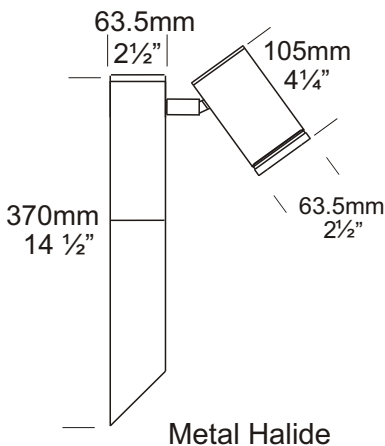
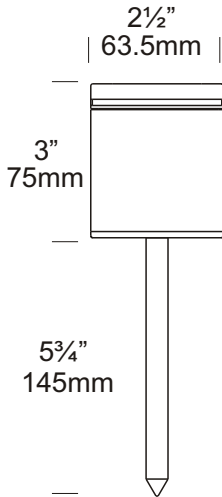

The Spike Spot is inserted into the ground and can be easily aimed by angling the luminaire in the desired direction. This fixture uses an MR16 lamp and is ideal for illuminating bushes and trees from ground level.

The luminaire is machined from a choice of 10mm solid aluminium with a UV stable powder coated finish, solid copper or 316 stainless steel with a clear, tempered, flush glass lens and high temperature silicon gaskets.

A GU10 version of this luminaire is also available for line voltage lamps. However, a longer luminaire body is needed to accommodate the longer lamp. The Spike Spot Metal Halide is extremely energy efficient, outputting 2-3 times the light of a halogen lamp, and uses a GX10 20 or 35 watt lamp.

Ordering Information

Luminaire Type	Material/Finish	Accessories
SS - Spike Spot	BK - Black BZ - Bronze GN - Green STAR - Silver Star WH - White WB - Birch DG - Dark Grey OG - Olive Green RG - Beige PR - Primrose COP - Copper SS - 316 Stainless Steel	CJK150 - Cable Joint Kit LENSSTEPF - Frosted Lens GG - Glare Guard (Not for Metal Halide) HCL - Hex Cell Louvre Adaptor /300 - Ground Spike 300mm (12") GU - GU10 Option MH - Metal Halide Option For LED options, refer to page 10.4 (dedicated LED), 10.4.3 (6 watt), 10.4.4 (3 watt) or http://hunza.co.nz/l.html

Ordering Example: SS COP - Spike Spot in Copper

SSGU BK - Spike Spot GU10 in Black

SSMH20 BK - Spike Spot Metal Halide 20 watt in Black

GG BK - Glare Guard in Black
(Accessories ordered separately)

HUNZA™ PURE OUTDOOR LIGHTING

HUNZA FACTORY
130 Felton Mathew Ave
Glen Innes
Auckland 1072
New Zealand

Ph: 64-9-528 9471
Fax: 64-9-528 9361
hunza@hunza.co.nz
www.hunza.co.nz

INTERNATIONAL CONTACTS:
www.hunza.co.nz/contacts.php

Specifications may change without notice.
Manufactured in New Zealand.
© 2011 Hunza Holdings Ltd.

Ver 1.4

Luminaire Construction

CNC machined from one of the following metals:

High corrosion resistant 63.5mm (2½") x 10mm (25/64") aluminium. End cap - solid aluminium 63.5mm (2½") rod, with chromate substrate and high UV resistant polyester powder coat

Colours Black, Bronze, Green, Silver Star, White, Birch, Dark Green, Olive Green, Beige, Primrose.

Copper 63.5mm (2½") x 10mm (13/32"). End cap - solid copper 63.5mm (2½") rod.

316 Stainless Steel 9mm (11/32"). End cap - solid 316 stainless steel 63.5mm (2½") rod.

Mounting

Ground spike 150mm (6") or 300mm (12") directly into the earth.

Features

Lens:

10mm (3/8") clear flush fit shatter resistant glass.

Lifetime Warranty.

Gaskets:

Silicone, iron impregnated 220°C (428°F).

Lamp Holder:

GU5.3 & GU10 - 350°C (662°F) ceramic multi contact lamp holder with 250°C (480°F) teflon cables.

Metal Halide GX10 - 350°C (662°F) ceramic multi contact lamp holder with 250°C (480°F) teflon cables.

Accessories:

Cable Joint Kit (Cat. CJK150).

Not approved for USA /Canada.

Frosted Lens (Cat. LENSSTEPF).

Glare Guard (Cat. GG).

Hex Cell Louvre Adaptor (Cat. HCL).

300mm (12") Spike (Cat. /300).

GU10 Option (Cat. GU).

Metal Halide Option (Cat. MH).

Standards

IP68



UL1838

Luminaire Weight

Alum .450kg (15oz)
Cop 1.250kg (2lb 12oz)
SS .960kg (2lb 1oz)

Power Supply

HUNZA™ Inground or Wall Mount
Transformer: not included.
Metal Halide - 230-240 volt ac 50Hz
built in ballast

USA and Canada:

HUNZA™ Wall Mount Transformer:
not included.
Metal Halide - 120 volt ac 60Hz
built in ballast

Luminaire: supplied with

MR16 GU5.3 20 or 35 watt lamp max.
GU10 - GU10 25 or 35 watt lamp max.
LED - Refer to previous page.

Metal Halide - GX10 20 or 35 watt lamp

USA and Canada:

MR16 GU5.3 20 watt lamp max.
GU10 Halogen - Lamp not supplied
LED - Refer to previous page.
Metal Halide - GX10 20 or 35 watt lamp

With a glare guard fitted, lamp wattage can be increased to 35 watts.

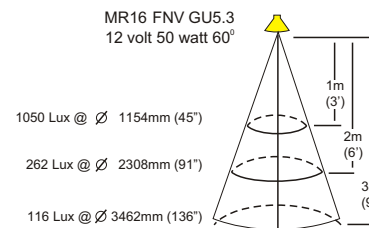
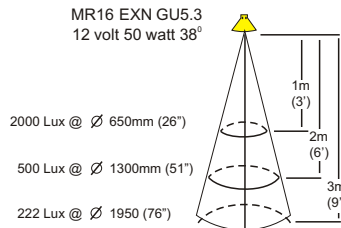
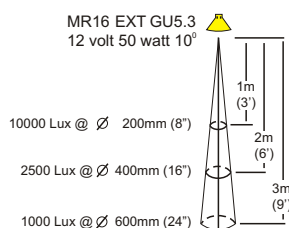
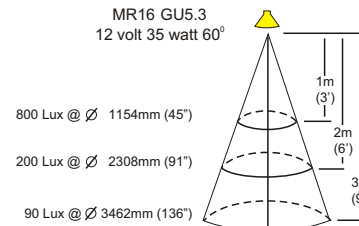
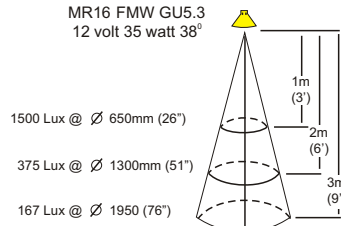
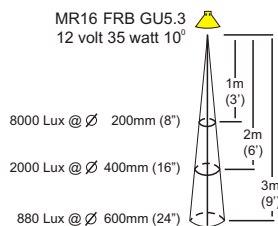
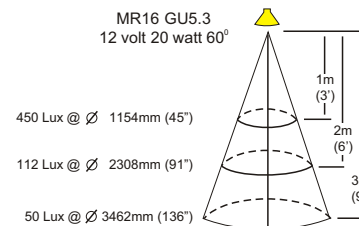
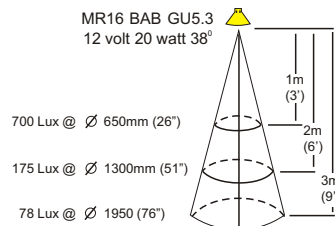
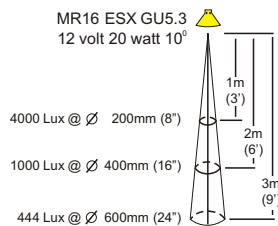

HUNZA™ PURE OUTDOOR LIGHTING

HUNZA FACTORY
130 Felton Mathew Ave
Glen Innes
Auckland 1072
New Zealand

Ph: 64-9-528 9471
Fax: 64-9-528 9361
hunza@hunza.co.nz
www.hunza.co.nz

INTERNATIONAL CONTACTS:
www.hunza.co.nz/contacts.php

Specifications may change without notice.
Manufactured in New Zealand.
© 2011 Hunza Holdings Ltd.

Ver 1.4